

Orbital Express Counters

Orbital Express Counters are quick, easy to assemble, and an attractive compliment to the Orbital Express Truss system or, apart from that, any booth space needing a display or work table.

Features & Benefits

- Express Truss set-up saves time and money
- Requiring no tools allows anyone to set-up
- Powder coated steel legs are both lightweight and durable
- The vacuum formation process leaves the table tops colorfast and stain resistant
- Available in a variety of colors, sizes, and styles
- Packs flat for easy shipping and storage



Left Facing Yin-Yang
OR-CT-1

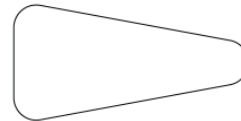

Triangular
OR-CT-2



90° Curved
OR-CT-3



Rectangular
OR-CT-4

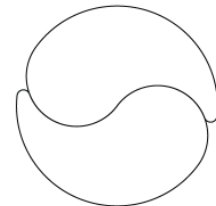

Full Yin-Yang
OR-CT-5

Hardware Specifications	Graphic Dimensions <i>Please use available templates when setting up artwork.</i>	Additional Info
<p>On average*: 36"(t) x 47.00"(l) x 23.5"(w) 927mm(t) x 1200mm(l) x 597mm(w)</p> <p><i>*Please see page 3 for model specific dimensions.</i></p>	<p>No graphics are available at this time.</p>	<p>Total Shipping Weight: 65lbs /29.48kg Shipping Case Dimensions: 50"(l) x 28"(w) x 12"(d) 1270mm(l) x 712mm(w) x 305mm(d)</p>

We are continually improving and modifying our product range and reserve the right to vary the specifications without prior notice. All dimensions and weights quoted are approximate and we accept no responsibility for variance. E&OE.

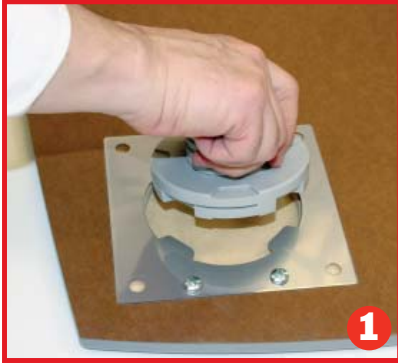

Set the *twist-lock connector* into the center of the *leg plate*.



Turn the *twist-lock connector* clockwise. The connector will lock into place as you turn.

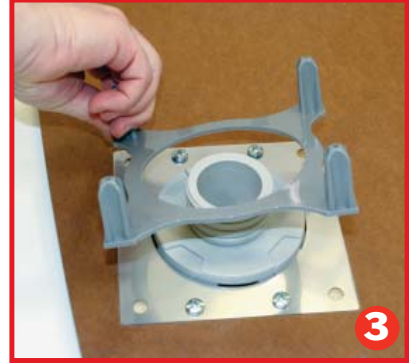

Place the "*Torque/Twist*" *leg-mount washer* over the *twist-lock connector* lining up the corner dimples on the *leg plate* to the corner nubs on the bottom of the washer.

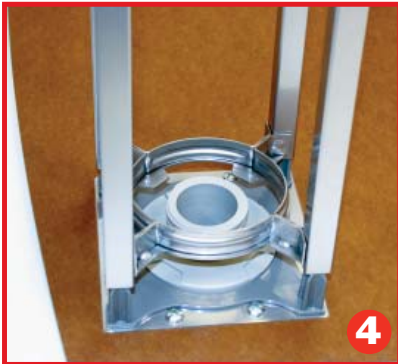

Line up the leg to the leg mounts on the washer. Push into place.



Place the *screw cap* into the center of the leg support ring and onto the threads of the *twist-lock connector*.



Turn the *screw cap* clockwise until it is securely in place as this will prevent lag wobble.



Repeat steps 1 - 6 for the remaining legs.



Rotate the table so that it is upright. Do not support the table on the side of the legs when rotating as damage may occur†.

†Weight limit for all models is 100lbs and should be evenly distributed on the table top.

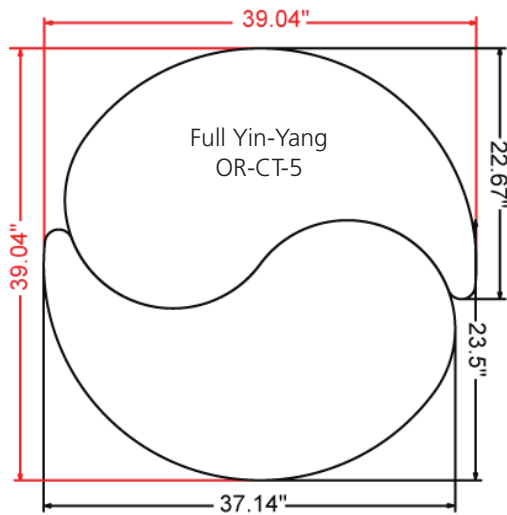
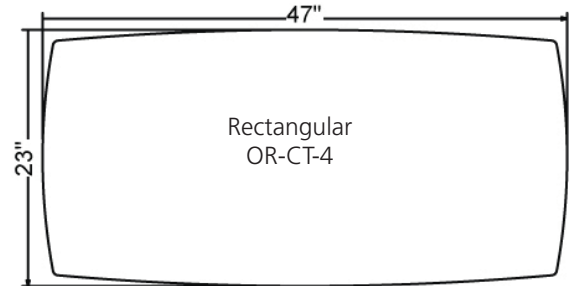
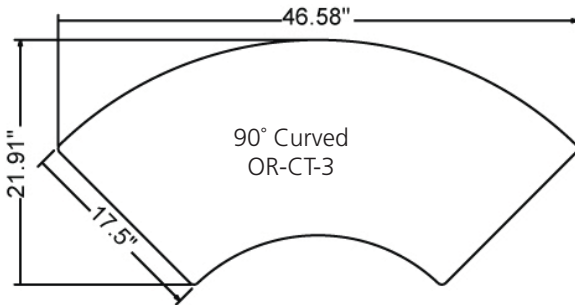
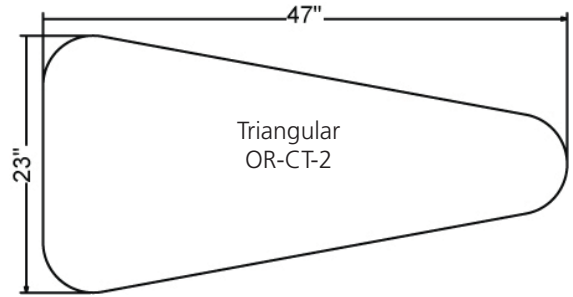
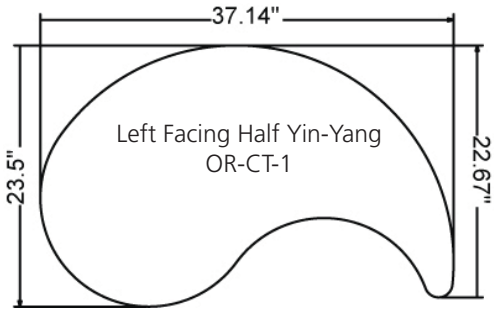

CHOICE OF COUNTER
COLORS:

BRUSHED SILVER

(SILVER TEXTURED)

BLACK (TEXTURED)

AMERICAN NATURAL

(LIGHT WOOD)

CLOVE (DARK WOOD)